

MODEL MQ20H

PEAK MARQUEE TENT

ASSEMBLY INSTRUCTIONS

IMPORTANT:

PLEASE READ INSTRUCTIONS PRIOR TO ERECTING THE TENT.

PROPER INSTALLATION WILL ENSURE MAXIMUM USAGE AND STABILITY OF THIS STRUCTURE.

IF FURTHER INFORMATION OR CLARIFICATION OF ANY PART OF THE ENCLOSED INSTRUCTION IS REQUIRED, PLEASE CONTACT:

WARNER SHELTER SYSTEMS LIMITED
1-800-661-6155 OR E-MAIL: warners@wssl.com

CAUTION

1. Each installation site must be evaluated and the proper securing method determined by the installer. Some soils require staking or securing different from that which was provided with the tent.
2. Good judgment and common sense must be used along with installation guidelines. It is the responsibility of the tent installer/maintainer to anticipate the severity of the weather along with the proper time and method of setup and take down. Evacuation of the tent is recommended before weather becomes extreme. A successful event is a safe event.
3. Proper safety equipment, such as hard hats, steel toe shoes, and safety glasses, should be used to ensure a safe setup and take down.

Table of Contents PAGES

1.)	TENT LOCATION.....	2
2.)	PARTS LIST	3
3.)	FRAME ASSEMBLY	4-5
	Post & Centrepole Assembly Step 2.....	PAGE 4
	Upper Frame Assembly Step 3.....	PAGE 4
	Cross Cable Installation Step 4 & 5.....	PAGE 4
	Cable: Slide Wall Installation (optional) .. Step 6.....	PAGE 5
4.)	TENT TOP INSTALLATION.....	5
	Protecting Tent Top Step 7.....	PAGE 5
	Unfolding Tent Top Step 8	PAGE 5
	Securing Tent Top to Frame Step 8A/8B	PAGE 5
5.)	ERECTING THE TENT	6-7
	Installing Posts Step 9	PAGE 6
	Installing Centrepole Step 10 - 11.....	PAGE 6
	Securing the Structure Step 12	PAGE 7
6.)	GUY ROPE INSTALLATION	7
7.)	WALL INSTALLATION.....	8
8.)	JOINER INSTALLATION	9
9.)	SUMMARY	10
10.)	CARE FOR YOUR VINYL TOPS	11
11.)	MAINTENANCE	11

Tent Location

VERY IMPORTANT!

Ascertain tops, guys, and other tent parts are in good operating condition. Any components showing damage should be replaced immediately.

Before unloading, review the proposed location of the tent. In doing so, take into account the following:

- Hazards** Locate, mark, and avoid any overhead or underground electrical, phone, gas, sprinkler or other lines. Take note and always be aware of any and all hazards. **DO NOT BEGIN ANY ASSEMBLY UNTIL THE HAZARDS HAVE BEEN MARKED AND CAN BE SAFELY AVOIDED.**
- Access** Plan the best route for bringing the tent and equipment for the setup onto and off the site.
- Drainage** Attempt to influence the location of the tent so that rain or melting snow can drain away.
- Obstacles** A clean, level and unobstructed site will provide an easy assembly of the tents.
- Weather** Do not attempt to setup the tent during thunderstorms, high winds or other extreme conditions.
- Safety** Before the set up, instruct the crew on safety procedures. All local safety and fire regulations must be followed.

ALL SITE PERSONNEL MUST FOLLOW OCCUPATIONAL HEALTH AND SAFETY PROCEDURES.

MODEL MQ20H PEAK MARQUEE TENT

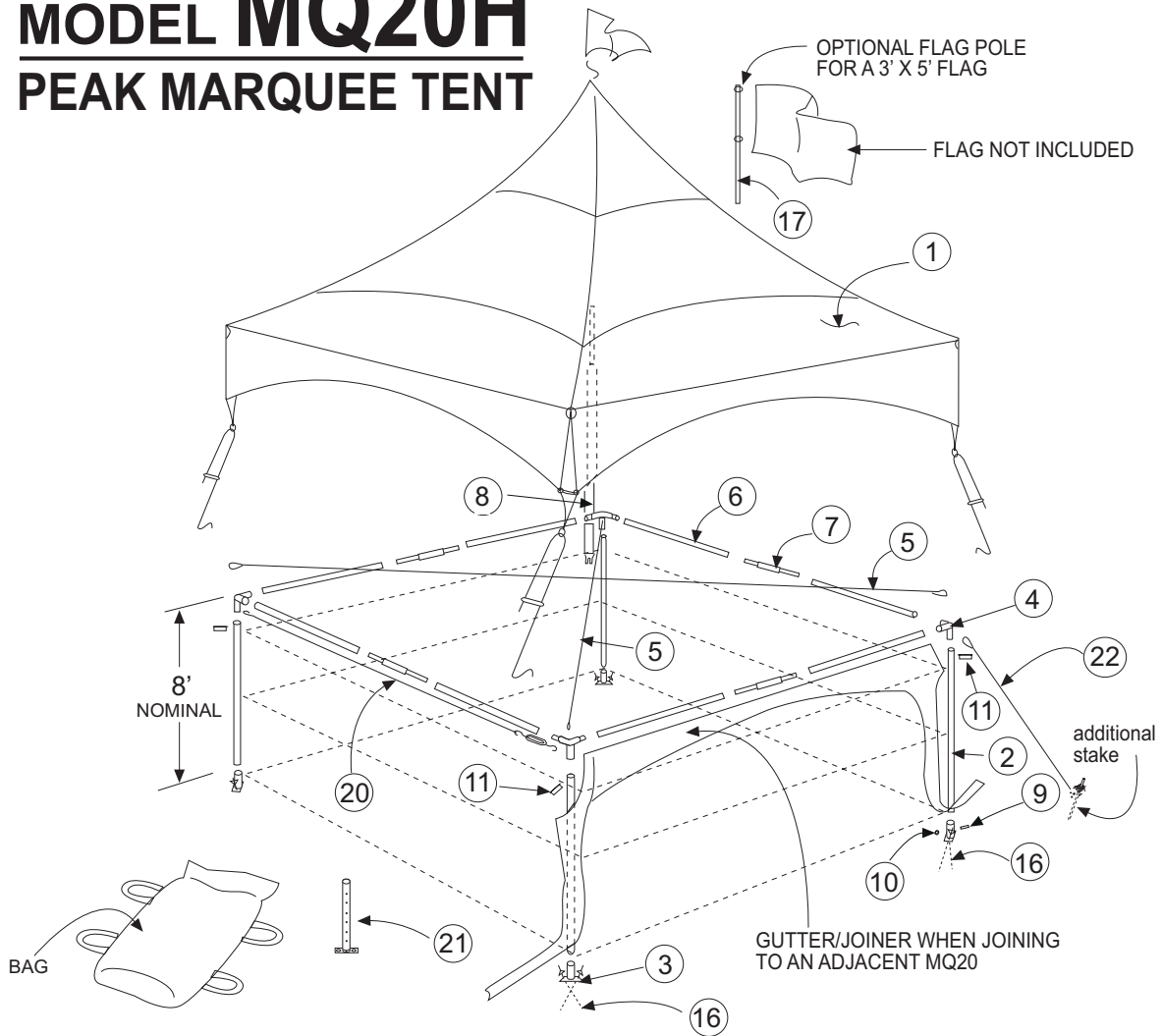

ITEM	PART	QTY	PART# 11033 ALUMINUM	PART #11037 STEEL
(2)	POST 8'	4	10591	10590
(3)	BASE; MQ FLAT	4		10514
(4)	CORNER 90°	4		10628
(5)	CROSS CABLE	2		7295
(6)	EVE TUBE	8	10630	7161
(7)	MIDJOINT	4	10667	7284
(8)	CENTREPOLE ASSY	1	10978	11544
(9)	BOLT 5/16-3 NC	4		4093
(10)	NUT 5/16 NYLOK	4		8369
(11)	LOCK PIN	5		7843
(1)	TENT TOP	1		10977
(16)	STAKE 3/4 - 34"	8		10666
(17)	FLAG POLE EXT.	1		9523
(19)	DROP SHEET	1		2100
(20)	CABLE: SLIDE WALL 20'	as required		10673
(21)	BASE: MQ ADJ. 24"	4		11064
(22)	GUY ROPE	as required		10689

Step 1

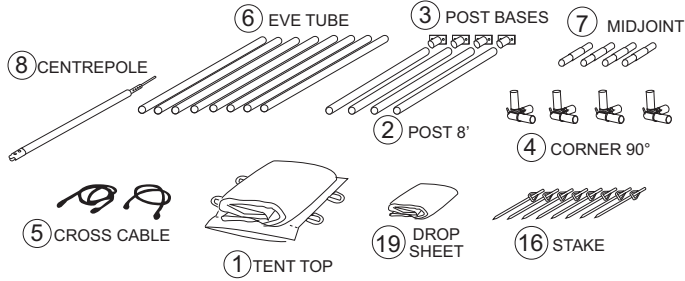

- Check all the parts before assembling the tent.
- Refer to assembly drawing on page 2 for part quantities and part numbers.

* Lock-pins not shown.

PRE ASSEMBLY

Step 2

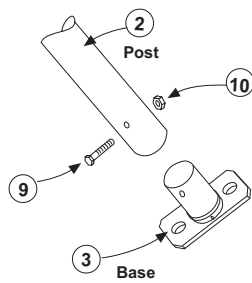

- Assemble the Post 8' (2) with the Base (3) using Bolts (9) and Nuts (10).
- Assemble the Centrepole (8) using the same type of Bolts and Nuts.

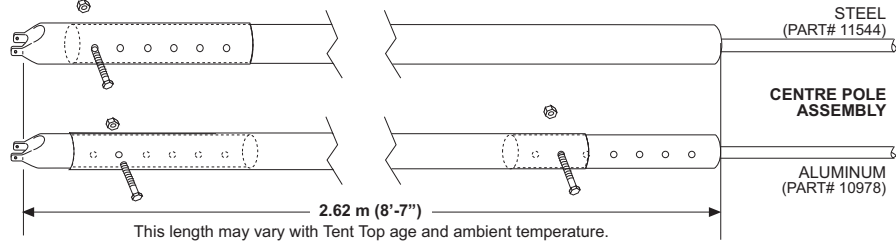

FRAME ASSEMBLY

Step 3

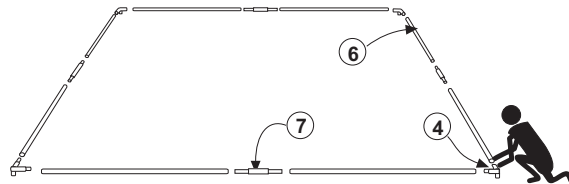

- Assemble Corner 90° (4), Eve Tubes (6), Mid Joints (7) by slipping one part to another to form the eve frame.

Step 4

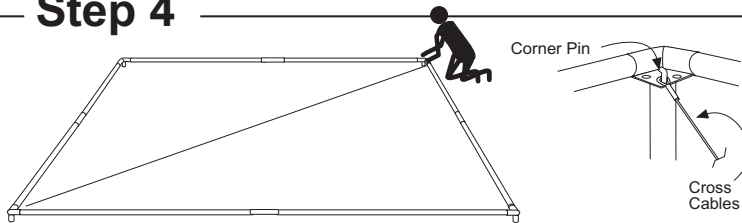

- Attach first Cross Cable (5) diagonally from corner to corner. Hook the cable end loop over the corner pin.

Step 5

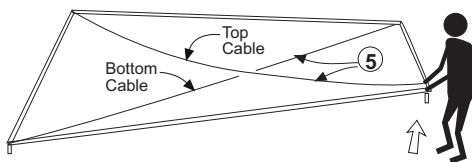

- Install second Cross Cable.
- To install last loop, lift last corner to shorten the distance between corners and hook the cable over the pin.
- Lowering the corner causes the corners to adjust their position and the cables to tighten.

Step 6

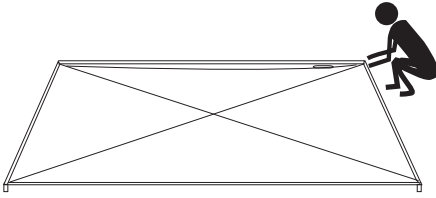

- If Sliding Walls are to be installed, attach the Cable for Slide Wall (20) to the Corners and tighten turnbuckle.

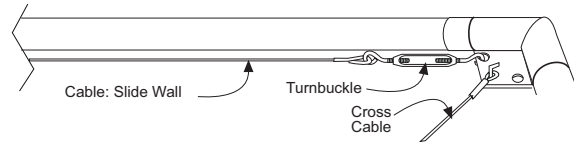

Step 7

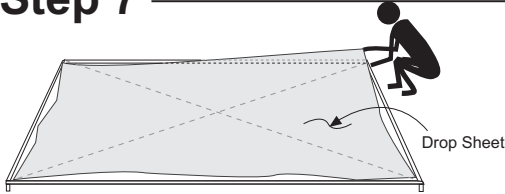

PROTECTING THE TENT TOP

- Unfold Drop Sheet (19) over the Cross Cables to protect the Tent Top and to keep the Tent Top clean.

Step 8

TENT TOP INSTALLATION

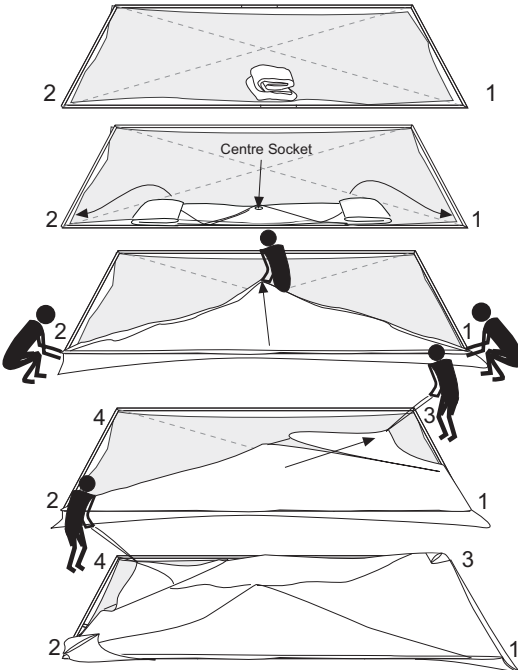

- * Corners are numbered here for ease of explanation only.
- Place the Tent Top midway along one side and unfold fabric toward the corners.
- * Ensure that centre socket pulls out towards the tent centre, if not rotate entire Tent Top bundle 180°.
- Pull centre socket, towards the centre.
- Attach webbing 1 & 2 to corresponding corners as shown in **STEP 8A** below.
- Pull upper layer towards the 3rd corner. Avoid stepping on Tent Top.
- Repeat to 4th corner.
- Attach webbings 3 & 4 to corresponding corners. **SEE STEP 8B** below.

ATTACHING WEBBING TO CORNER LOOP

Step 8A

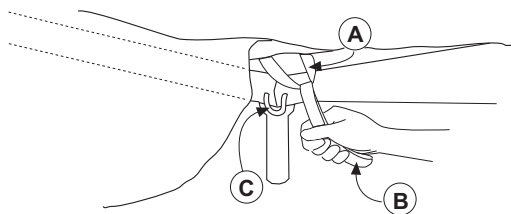

- Attach one corner of the Tent Top to the frame by pulling handle (B) to place loop webbing (A) under the corner loop (C).

Step 8B

ATTACHING THE LAST

- Attach as in 8A, but if tight, insert a stake through webbing (A) and press down and under until the webbing slips under the corner loop (C).

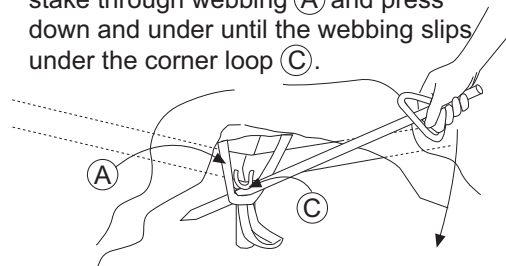

ERECTING THE TENT

Step 9

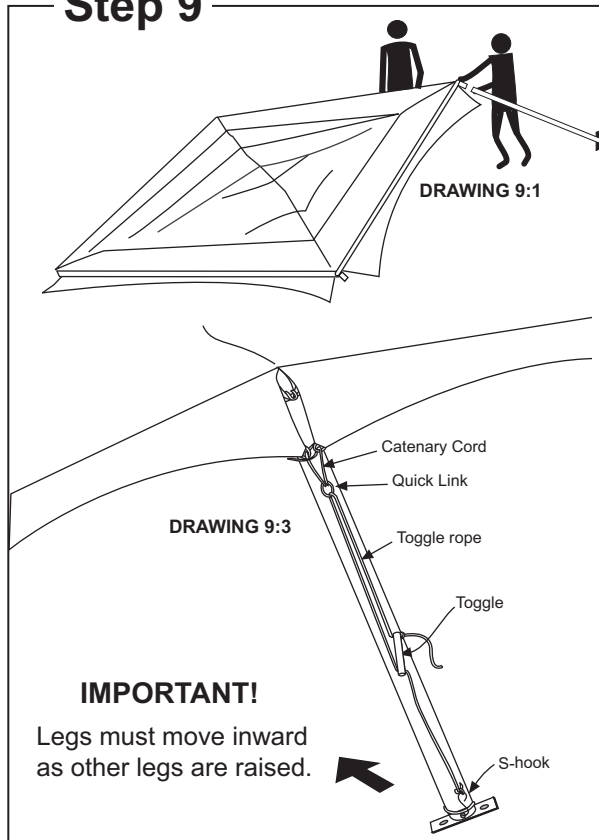

INSTALLING POSTS

- To install the first Post, lift one corner and slide the Post over the Corner sleeve.

SEE DRAWING 9:1

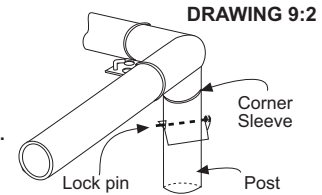

- Lock post in place using lock-pins ⑩.

=>

- Insert s-hook into the hole in the Base. SEE DRAWING 9:3

- Tension toggle rope by pulling the toggle down. SEE DRAWING 9:4

- Repeat procedure for the second post.

||
v

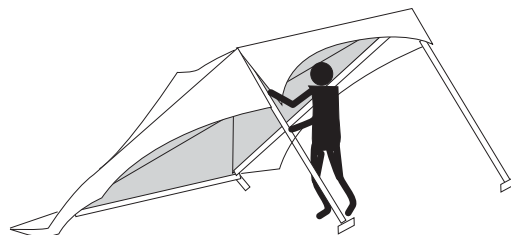

Step 10

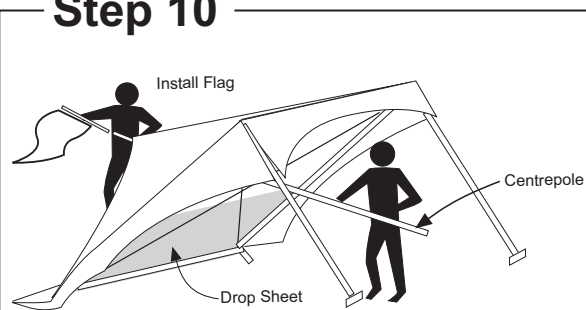

CENTREPOLE INSTALLATION

- Push Drop Sheet towards the lower half of the frame to expose the Cable intersection.
- Insert the Centrepole ⑧ through the center socket of the Tent Top.
- Install the Flag on the Centrepole.

* Be careful when stepping on fabric. Removing shoes would be recommended to avoid soiling or damaging the Tent Top.

Step 11

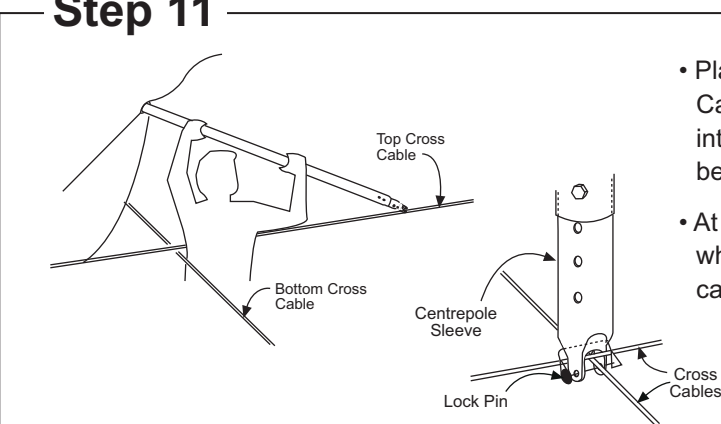

- Place the Centrepole lower end on the top Cable and slide it toward the Cross Cable intersection, wedging the Centrepole between the cover and the cables.

- At the intersection, push down bottom cable while pulling up the top cable to set both cables directly below the Centrepole sleeve.

- Secure the Centrepole to the cables using the Lock-Pin.

Step 12

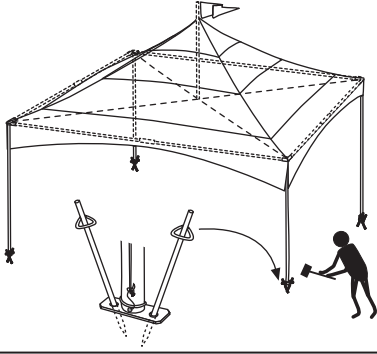

- Remove Drop Sheet and fold up keeping clean side in. $\parallel \downarrow$

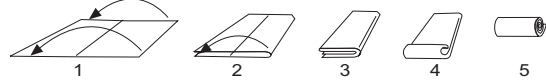

- Install the remaining Posts. Allow bases to slide.
- Vertically position the Posts and drive the Stakes through each Post Base.

SECURING TOGGLE ROPES

- Tension the Tent Top by tightening each toggle rope.* Tie off slack rope tails to main ropes.**

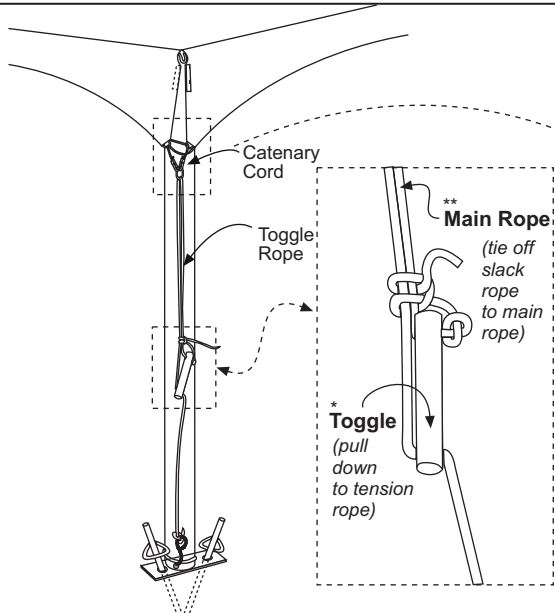

Catenary cord assembly detail:



D-rings should overlap once toggle rope is tensioned.



IMPORTANT: Each installation site must be evaluated by installer to determine proper securing method. Site conditions may require guying and/or anchorage different from what was provided with the structure.

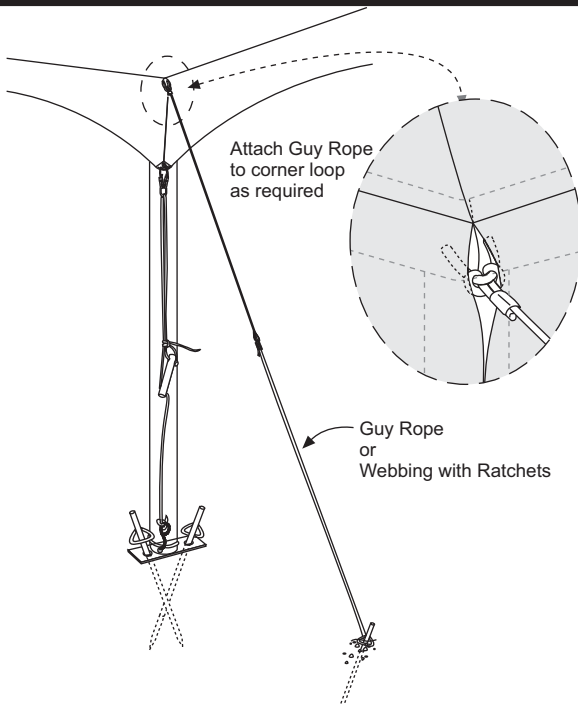

- For inclement weather, Guy Ropes are recommended.

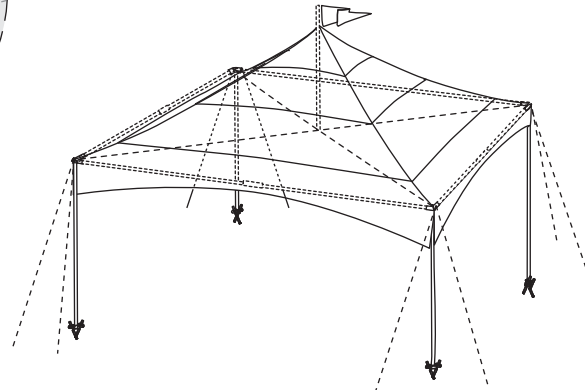

Wall Installation

*** Before installing walls, make sure toggle ropes are evenly tensioned and the Tent Top is evenly positioned on the frame.**

Check that Cable for Slide Wall is properly tensioned. Tighten with turnbuckle if needed.

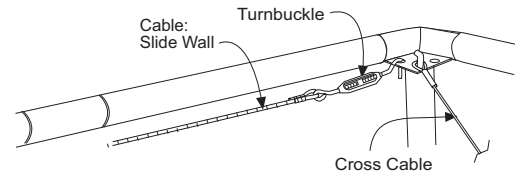

1. Clip walls to Cable.

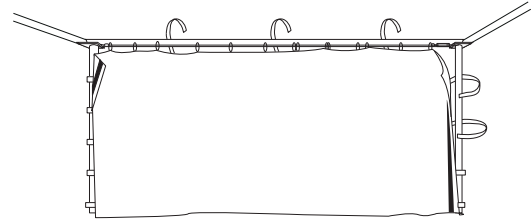
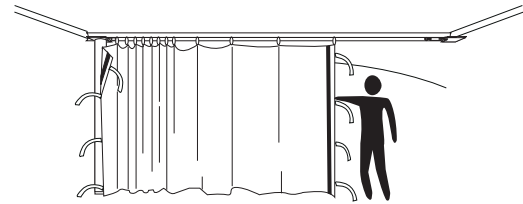
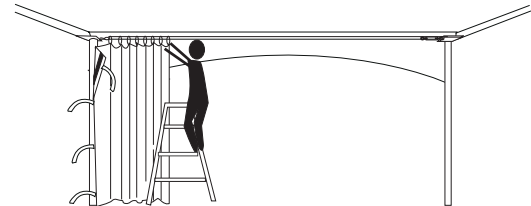
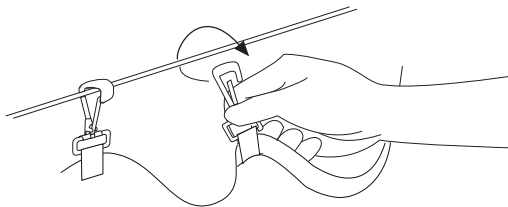

2. Secure side wall straps to Posts. =>

3. Secure top wall strap to Eve Tube.

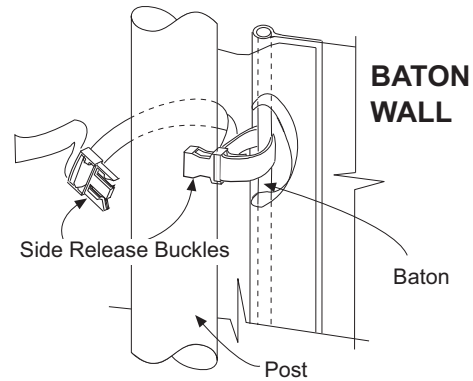
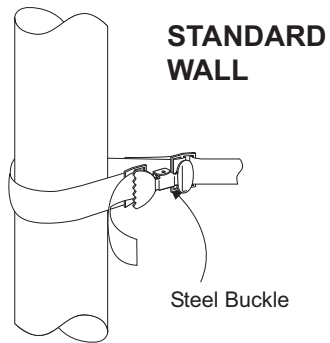

4. If two or more walls are installed, fasten velcro strips on the edges of the walls for a wind proof seam.

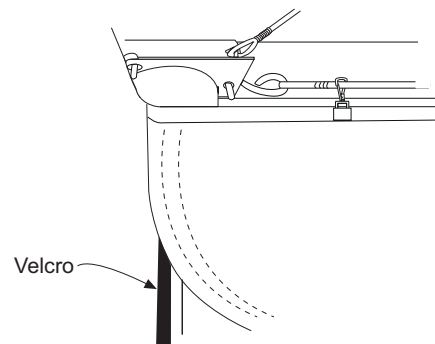
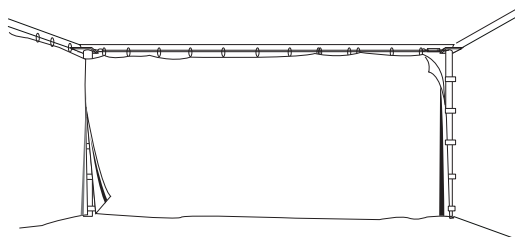

Joiner Installation

1. Unfold joiner
2. Attach velcro straps to Eve Tube while tensioning toward corners.

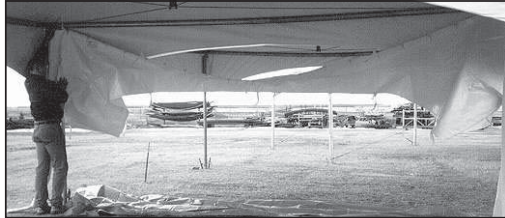
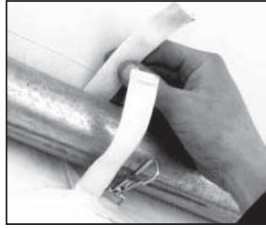

3. Attach clips to Cable: Slide Wall.

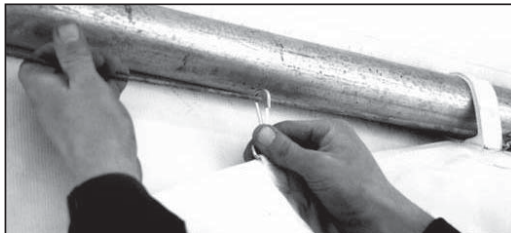

4. Repeat procedure in the adjacent tent.



5. Insert lapels between two posts

(* Loosen toggle ropes to slip lapels underneath it.)

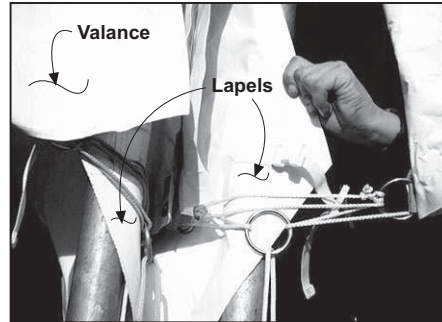

6. Spread lapels under valance.



7. Insert the strap on the lapel through the ring in the adjacent valance and secure buckles. Pull loose strap to tighten.

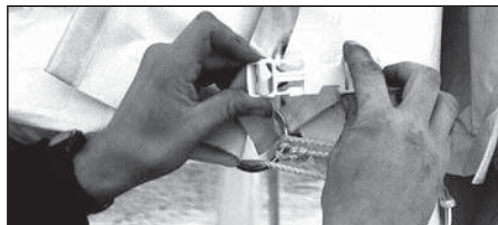
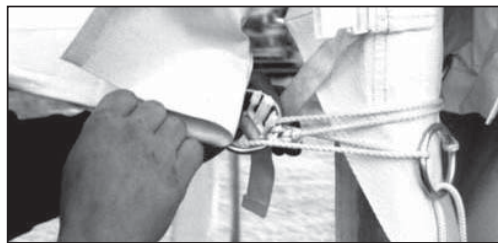

8. Straighten downspout and retension toggle rope.

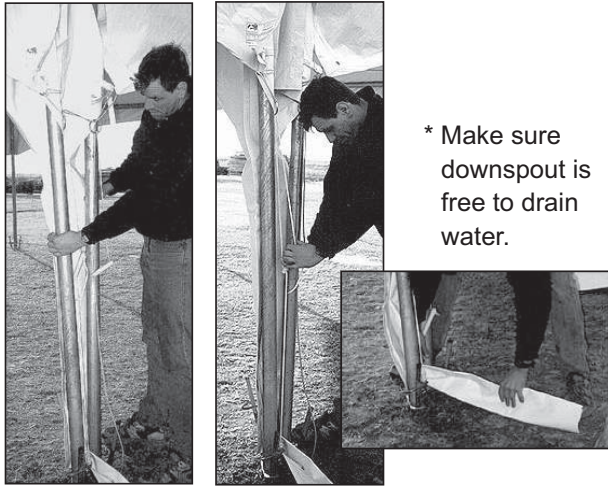

* Make sure downspout is free to drain water.

10. From inside, fasten joiner and wall velcro together to hide posts.

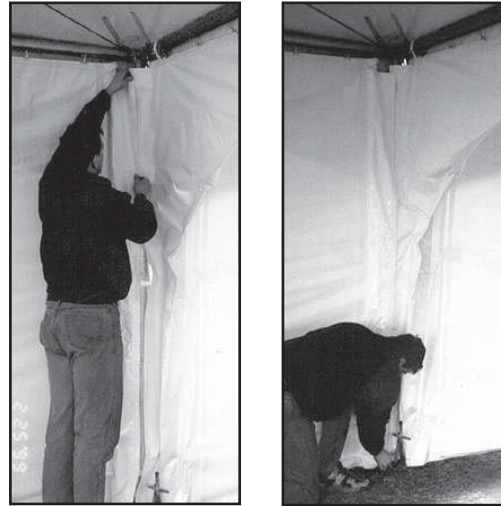

9. Fasten canopy velcros from top to bottom over the lapel. Flatten for a neat seal. =>

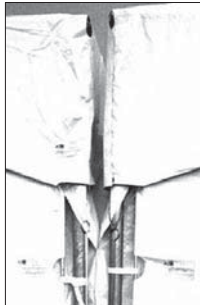

<= Correctly installed joiner.



11. Joiner should smoothly follow the catenary curve.



Summary

1. Check parts.
2. Assemble Corner 90°, Eve Tubes and Midjoints to form upper frame.
3. Install Cross Cables.
4. Spread Drop Sheet over Cross Cables to protect Tent Top.
5. Unfold Tent Top.
6. Attach Tent Top webbings to corner loops.
7. Install two Posts. Secure with Lock-Pin and insert the s-hook of the toggle rope into the hole in the Post Base.
8. Move Drop Sheet to clear the Cross Cable intersection area.
9. Insert Centrepole through the centre socket.
10. Install Flag from outside.
11. From inside, place Centrepole sleeve on the Cross Cable intersection and secure with Lock-Pin.
12. Remove and fold Drop Sheet.
13. Install remaining Posts.
14. Drive Stakes through each Post Base.
15. Tension each toggle rope.
16. Install Guy Ropes, Walls, Joiners.
17. Make final inspection to ensure everything is in operational condition.
18. Clean up site.

To take down the tent, reverse the preceding steps.

Care for your Vinyl Tops

Care for your vinyl tops as you would to any vinyl surface.

Use mild detergent industrial cleaner with no chlorox.

To clean, spread tent top on clean surface. Try laying fabric on astro turf to wash. Dirt and tiny sharp particles tend to fall into the carpet pile, away from the fabric. Some renters set up the tents to wash and dry.

Spray detergent solution onto fabric. Use more concentrated solution on soiled areas.

Rub, scrub or brush; elbow grease is an essential ingredient. Pressure washing may harm your tent fabric and is not recommended. Rinse with clean water, hang cover and allow to dry thoroughly.

DO NOT put your tent away damp. Mold & mildew will grow and discolour the cover. Always dry the tent. To speed things up, try fans or carpet air blowers and hanging the canopy.

Trees can be a problem with sap, pollen, etc. Flowers & leaves, sometimes contain powerful natural organic chemicals capable of staining your beautiful tent. Beware of tents under trees!

- Always use a drop sheet during setup and take down.
- Have some cleaning equipment with you for on-site clean ups.
- Besides being a fire hazard, BBQ's add a lot of grease and grime to the underside of the tent and are not recommended even with the walls off.

STORAGE - store vinyl canopies and other parts **clean and dry**.

Maintaining Your Tent

Your **WSSL Peak Marquee Tent** will serve your needs now and for many years to come. Tighten the top and walls to avoid wind flap and consequent wear on the fabric. Periodically the fabric should be cleaned; in place or when dismantled. Using mild detergent, water and a deck mop, clean wipe the fabric roof or walls. Let dry. Repair any damage to the fabric using a WSSL Fabric Repair Kit. Repair or replace any possible damaged frame parts.

TENT FABRIC CHARACTERISTICS

MILDEW - If mildew is detected, remove it immediately. Regardless of treatment, there is no way to absolutely stop fungus growth if it is prevalent in your area. No tent can be guaranteed not to mildew. Vinyl fabrics may mildew in storage if not properly stored. **BE SURE TENT IS CLEAN AND DRY BEFORE STORING IN A COOL, DRY PLACE.**

WATER RESISTANCE - WSSL tents are made of waterproof vinyl/polyester fabrics using waterproof welded seams. Because these fabrics are impervious to moisture, condensation may occur with some heaters and if the tent is poorly vented. Do not confuse water condensation with leakage especially on vinyl tents.

FLAME RESISTANT - All WSSL tent tops and walls are fire retardant. All WSSL tent fabrics satisfy ULC-S109, NFPA 701, and California fire marshal tests for fire resistance.

FADING-OPACITY - Variable sun conditions, exposures, types of materials and fabric finishes all influence the weathering of fabrics. WSSL fabrics have been chosen for their colour and opacity consistency and stability.

COLD CRACK - Chosen for their tolerance to cold cracking, our translucent fabrics remain flexible at temperatures below 0°F. The opaque fabrics are laminated and therefore become stiffer as the temperature drops. When the temperature is near 32°F, care should be taken in folding and moving the fabric to prevent cracking of the vinyl, especially the walls with windows.

WSSL TENTS

Warner Shelter Systems Limited creates fabric-clad structures to suit virtually every purpose, from special events, trade shows, catering and outdoor concerts to warehousing and industrial use. Our award-winning tents are user-friendly, durable and set-up quickly.

We have earned a reputation for providing a high level of service to customers since 1970. It is a pleasure to serve you. Please contact us for further information.

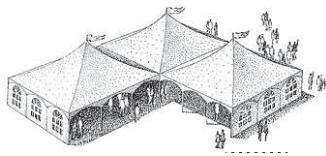

PEAK MARQUEE TENT

Peak Marquee is a favorite for special events, fairs, trade shows, and food service use. With its ease of setup and lightweight frame, the Marquee is user-friendly as well as attractive. It has a clearspan interior and guy ropes are not necessary under most conditions. Available in nine sizes, 100 - 1,380 sq. ft. Marquees can be linked together in many configurations and can also be joined with Peak Pole Tents.



MODULAR CLEARSPAN BUILDING

Modular Buildings are often used for large special events, but are equally suitable for warehousing, retail and industrial use and environmental projects. 'MODS' are spacious and strongly built, ideal as either temporary or semi-permanent structures. They are available with 10', 14' or 20' walls, and building width options range from 40' to 160'. Length can be varied by adding or removing 15' modules.



PEAK POLE TENT

Peak Pole Tents are a great solution for large functions of all types, combining the nostalgic appeal of old-fashioned circus "big tops" with the advantages of modern technology. Available in 30', 40', 60', 80', or 90' widths and length can be varied by adding or removing sections. Peak Pole Tents may be joined with Peak Marquees since both use compatible gutters and walls.



ARABESQUE THEATRE TENT

The Arabesque Theatre Tent with its high arched ends allows generous height over a stage at one end and bleacher seating at the other. These tents, singularly or joined together, create a large, attractive, clear-span interior and have been used extensively for major fairs, festivals and exhibitions across North America. By removing one end of the Arabesque it becomes a stage cover.



ARABESQUE STAGECOVER

The Arabesque Stagecover creates a striking backdrop for any outdoor concert with its dramatic curves and bold stripes. It is renowned for its superb acoustic projection and excellent sight lines. The Arabesque's strong frame supports a variety of lighting hardware. Available in five sizes to accommodate most stage dimensions and groups of entertainers up to full orchestras.



DOME STAGECOVER

With great acoustics and excellent sight lines, our attractive **SC series** is available in five sizes, and the SC-70A is large enough to accommodate a full orchestra. From music to theatre, WSSL Dome Stagecovers provide a perfect way to showcase outdoor entertainment of every kind. WSSL Dome Stagecovers can be put up and taken down quickly and stored easily.

Copyright © 2004 by Warner Shelter Systems Limited

All rights reserved.

This manual or any part thereof must not be reproduced in any form without the written permission of Warner Shelter Systems Limited.

The information contained in this manual is intended for the exclusive use of the customer and/or Building Authority.

Warner Shelter Systems Limited is not responsible for personal injury and damage to property caused by the application of the procedures documented in this manual in any situation not explicitly contemplated herein.



Warner Shelter Systems Limited

Tents and Fabric-Clad Structures

9811 - 44th Street, SE, Calgary, Alberta, Canada T2C 2P7
Phone: (403) 279-7662 or (800) 661-6155; Fax: (403) 236-2633
Website: www.wssl.com • E-mail: wamer@wssl.com